

Flow control valve

ASC Series

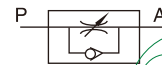

Ordering code

ASC 300 10 T

① ② ③ ④

① Model	② Code	③ Port size	④ Thread type
ASC: Flow control valve	100: 100 series	06: 1/8"	T: NPT
	200: 200 series	08: 1/4"	
	300: 300 series	10: 3/8" 15: 1/2"	

Specification

Model	ASC100-06	ASC200-08	ASC300-10	ASC300-15	
Fluid	Air (to be filtered by 40 μm filter element)				
Port size [Note1]	1/8"	1/4"	3/8"	1/2"	
Pressure range	7~135psi(0.05~0.95MPa)				
Proof pressure	215psi(1.5MPa)				
Temperature	-20~70℃				
Material body	Aluminum alloy				
Flow (L/min)	Control flow	200	450	1250	1650
	Free flow	400	800	1500	2500

[Note1] NPT thread is available.

Product feature

1. Small and compact structure.
2. Allows air to exhaust and cut off air flow. The adjustment screw is both sensitive and precise.
3. Can be mounted in various position to facilitate installation and application.

Inner structure

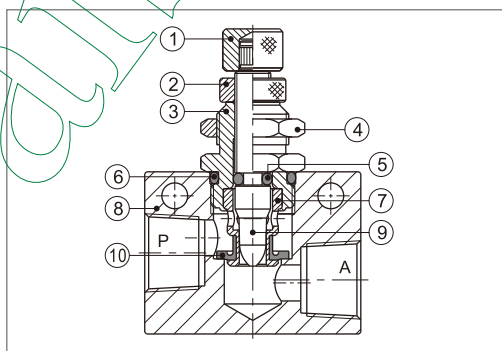

No.	Item	No.	Item
1	Adjustment cap	6	O-ring
2	Clamping cap	7	Throttle sheath
3	Throttle body	8	Body
4	Hexagon nut	9	Throttle column
5	O-ring	10	Spool O-ring

ASC Series

Flow chart

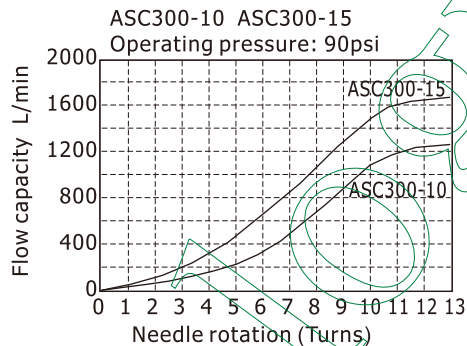
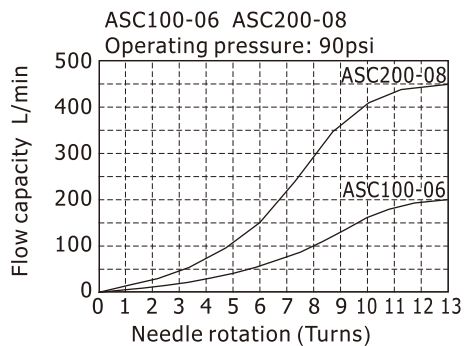

Dimensions

ASC100\ASC200

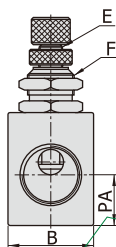
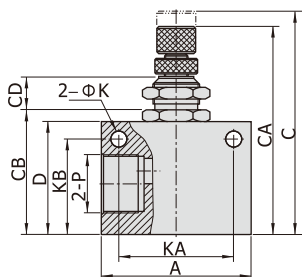

ASC300

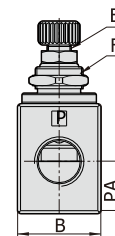
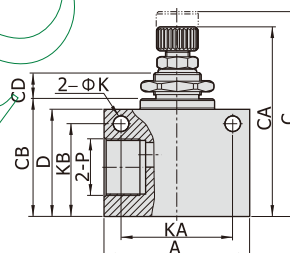
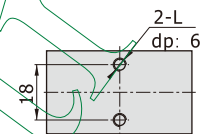

Model/Item	A	B	C	CA	CB	CD	D	E	F	K	KA	KB	L	P	PA
ASC10006	32	18	52.5	47	26	8.6	23	M6×0.5	M12×0.75	4.3	22	18	M4×0.7	1/8"	10
ASC20008	36	18	56.5	51	30	8.6	27	M6×0.5	M12×0.75	4.3	26	23	M4×0.7	1/4"	13.5
ASC30010	50	28	74	65	40.5	10	37	M8×0.75	M16×1.0	5.3	35	32	M4×0.7	3/8"	17.5
ASC30015	50	28	74	65	40.5	10	37	M8×0.75	M16×1.0	5.3	35	32	M4×0.7	1/2"	17.5