

Foot pedal valve(5/2way)

4F Series

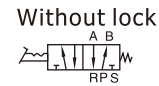

Ordering code

4F210 08 L T

① ② ③ ④

① Model	② Port size	③ Note	④ Thread type
4F210: 5/2 way Foot pedal valve	08: 1/4"	Blank: Without lock L: With lock F: With guard LF: With lock and guard	T: NPT

Specification

Model	4F210-08	4F210-08L	4F210-08F	4F210-08LF
Fluid	Air (to be filtered by 40 μm filter element)			
Operating	Acting type controlled by foot			
Port size [Note1]	1/4"			
Valve type	5/2 Way			
Pressure range	0~145psi(0~1.0MPa)			
Proof pressure	215psi(1.5MPa)			
Temperature	-20~70℃			
Material body	Aluminum alloy			
Lubrication	Not required			

[Note1] NPT thread is available.

Product feature

1. The aluminum foot pedal is designed with direct acting, which is steady and reliable.
2. If the duration of direction-change is long, the valves with lock may be selected.
3. The clamping framework is steady and reliable that it is easy and quick to unlock.
However, with the limitation of the dimension of structure, it can not bear frequent strong impact.
4. Plastic guard with high strength may be selected.

Foot pedal valve(5/2way)

4F Series

Inner structure

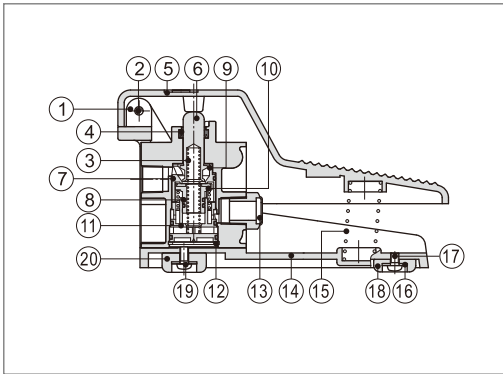

No.	Item	No.	Item	No.	Item	No.	Item
1	Pin	6	Spool	11	Bottom cover	16	Washer
2	Screw	7	O-ring	12	C clip	17	Screw
3	Spring	8	O-ring	13	Silencer	18	Base pad
4	E clip	9	Front cover	14	Base	19	Screw
5	Pedal	10	Piston	15	Pedal-spring	20	Base pad

Note ⚠ Lockable type should be added grease periodically to ensure the machine can work regularly.

Dimensions

4F210

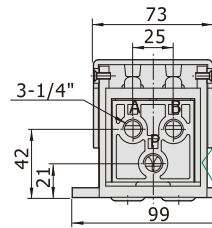
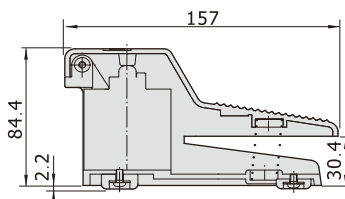

4F210L

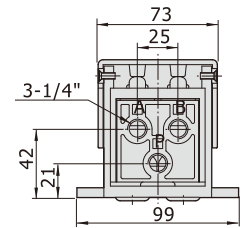
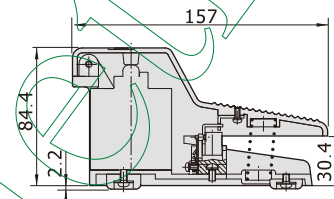

4F210F

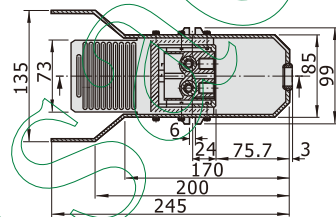
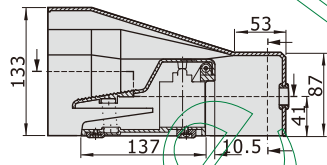
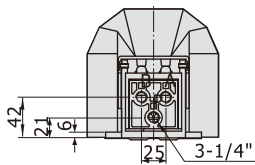

4F210LF

